

1. Important safety instructions

All the installation and replacement operations must be done by specialized personnel only. When installing the device, please turn off all power devices and comply the national installation regulations.

The final user and/or the installer will take the responsibility of ensuring electric, mechanical and thermal compatibility of the system against the structures on which it will be mounted and against the devices connected to it. Do not exceed listed loading indicated in the relevant section and respect fixing distances during the track mounting. The track, its components and also the adapters can't be used with accessories without the Quality Mark.

On VF track one can use only VF connections. VF connections can be used only with VF tracks.

The accessories should be installed correctly according to the installation instructions.

The company as a manufacturer is not responsible for the safety and functioning of the system if parts not belonging to it are used or if any deviation from the installation instructions occurs. It is then the user's responsibility to ensure the electrical, mechanical and thermal compatibility between the product and the fixtures used with it.

2. Track Drawing

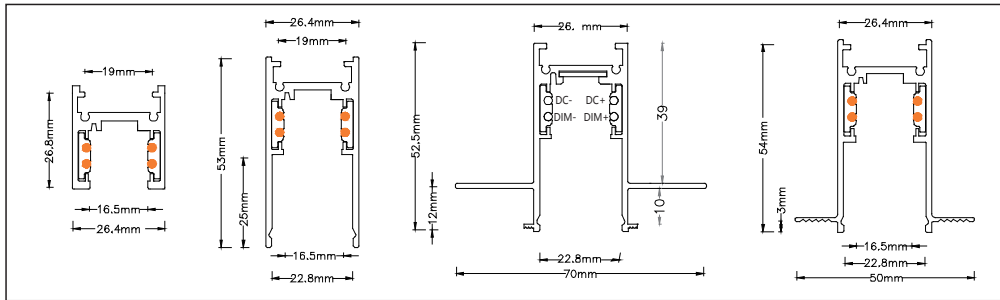

3. End Cap Installation instruction

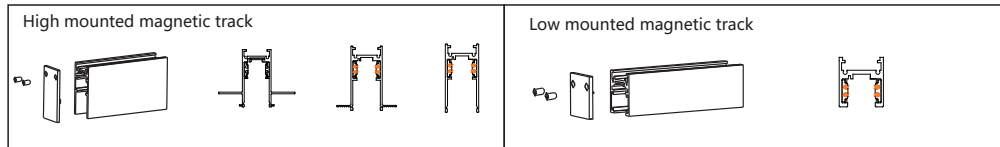

The end cap is used for the first track and the last track of the line. When fixing it to the track, two screws need to be tightened.

4. Track connection instruction

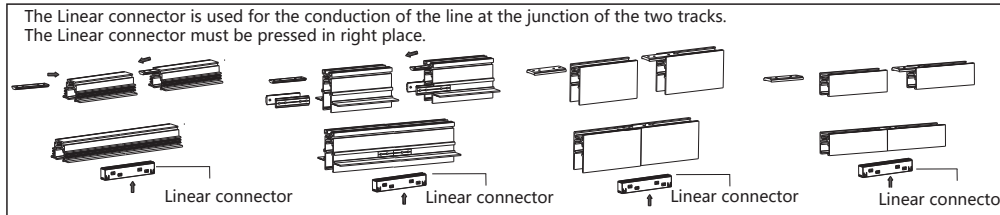

L-shape outside corner aluminum connector

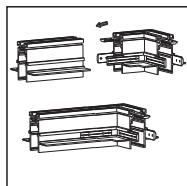

L-shape inside corner aluminum connector

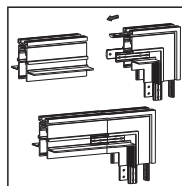

Outside corner electrical connection

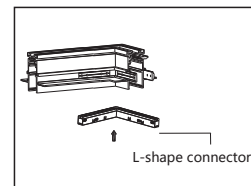

Inside corner electrical connection

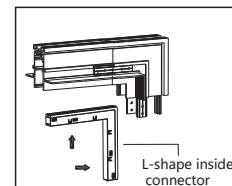

Suitable for track installation of all model

5. Driver installation instruction

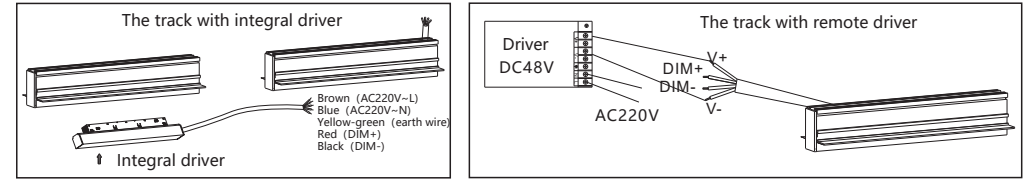

6. Track installation

Recessed magnetic track (Splint)

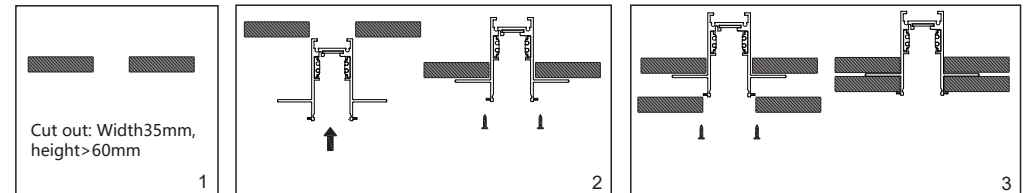

Cut holes in the load-bearing board according to the size requirements (Fig. 1), then fix the track on the load-bearing board with screws according to the operation shown (Fig. 2), then lay plasterboard on the lower end and fix it with screws (Fig. 3), and finally cover with net and plaster it (the cover of the track must be closed when plastering). (Note: screws are provided by the installer himself)

Recessed magnetic track (Plaster)

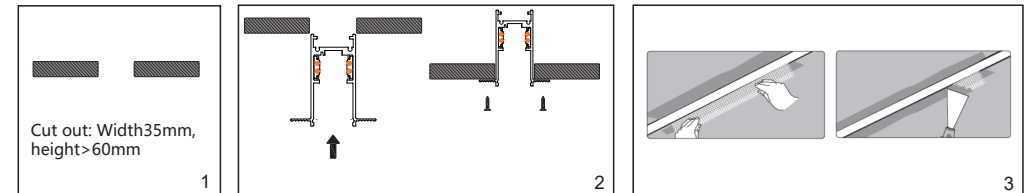

Cut holes in the load-bearing board according to the size requirements (Fig. 1), then fix the track on the load-bearing board with screws according to the operation shown (Fig. 2), and finally cover with net and plaster it (Fig. 3) (the cover of the track must be closed when plastering). (Note: screws are provided by the installer himself)

Surface mounted magnetic track

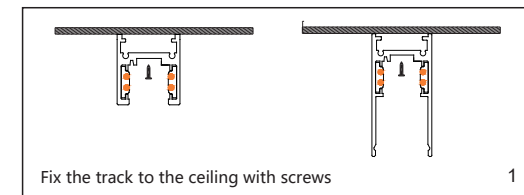

Fix the track to the ceiling with screws

Suspended mounted magnetic track

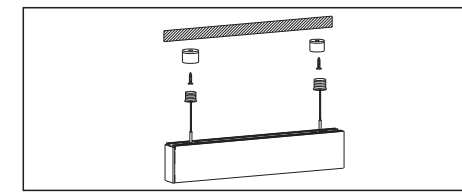

Fix the studs on the lifting kit to the ceiling as shown, then screw the screws to the studs and make sure they are secure, finally adjust the slings to the right height and tighten the screws at both ends of the lifting plate.

Diagram of luminaire installation and removal

